

**Data sheet | Item number: 765-1703/200-000**

16-channel digital input/output; IO Link Class A Hub; DC 24 V / 2.0 A; 8xM12 connection; HubLine

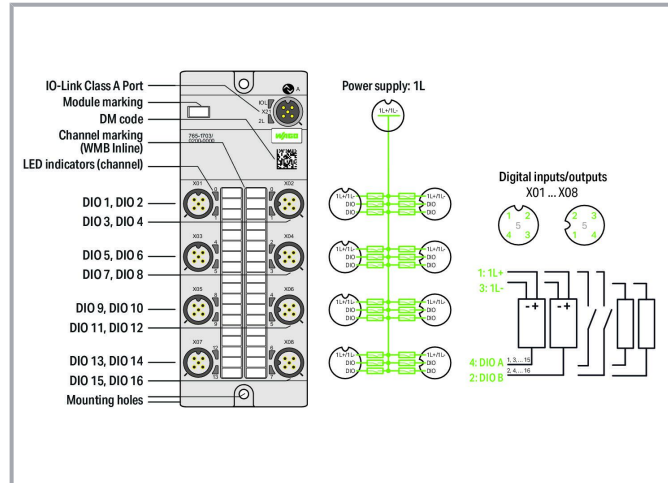

[www.wago.com/765-1703/200-000](http://www.wago.com/765-1703/200-000)



**Data**

**Technical data**

**IO-Link**

Communication

IO-Link Class A Slave

IO-Link Class A Slave

Connection technology: communication/fieldbus

1 x A-coded M12; 5-pole

**Device Functions**

Parameters

Input filter

Output current

Temperature

Diagnostics

Undervoltage; Overcurrent; Overload; Overtemperature

Subject to changes. Please also observe the further product documentation!

WAGO GmbH & Co. KG

Hansastr. 27

32423 Minden

Phone: +49571 887-0 | Fax: +49571 887-169

Email: [info.de@wago.com](mailto:info.de@wago.com) | Web: [www.wago.com](http://www.wago.com)

Do you have any questions about our products?

We are always happy to take your call at +49 (571) 887-44222.

## Digital inputs/outputs

Number of digital inputs	16
Number of digital outputs	16
Connection technology: inputs/outputs	8 x A-coded M12; 5-pole
Voltage signal type	24 VDC
Input characteristic	High-side switching
Input filter	0.2 ... 20 ms
Input characteristic	Type 3, per IEC 61131-2
Output current (per channel)	2 A

## Power Supply

Connection technology: supply	1 x A-coded M12; 5-pole; via IO-Link port (1L)
Supply voltage	24 VDC (18 ... 31.2 V); 1L
Power consumption (max.)	4000 mA
Power consumption (note)	1L: 0.2 A + load current
Reverse voltage protection	Yes

## Geometrical Data

Width	60 mm / 2.362 inch
Height	30 mm / 1.181 inch
Depth	158.5 mm / 6.24 inch

## Mechanical Data

Weight	170 g
Conformity marking	CE

## Environmental Requirements

Surrounding air temperature (operation)	-25 ... +70 °C
Surrounding air temperature (storage)	-40 ... +80 °C
Protection type	IP67
Protection class	III per EN 61140, IEC 61140, VDE 0140-1
Operating altitude	0 ... 2000 m
Pollution degree (5)	3 per EN 60664-1
Overvoltage category	II (EN 60664-1)
Vibration resistance	5g per IEC 60068-2-6

Subject to changes. Please also observe the further product documentation!

Shock resistance	Short-term: 50g/11 ms/half-sine per IEC 60068-2-27; Long-term: 30g/6 ms/half-sine per IEC 60068-2-29
EMC immunity to interference	per EN 61000-6-2
EMC emission of interference	per EN 61000-6-4

## Commercial data



PU (SPU)	1 Stück
Packaging type	box
Country of origin	DE
GTIN	4055143949989
Customs tariff number	85371098990

## Required accessories



### Tool

Assembly tool		
	<b>Item no.: 206-701</b> Torque wrench M8 and M12; Assembly kit	<a href="http://www.wago.com/206-701">www.wago.com/206-701</a>

### Cover

Cover		
	<b>Item no.: 756-8102</b> M12 protective cap; for unused sockets	<a href="http://www.wago.com/756-8102">www.wago.com/756-8102</a>
	<b>Item no.: 756-8103</b> M12 protective cap; for unused plugs	<a href="http://www.wago.com/756-8103">www.wago.com/756-8103</a>

## Marking accessories

Marking strip		
	<b>Item no.: 2009-110</b> Marking strips; for Smart Printer; on reel; not stretchable; plain; snap-on type; white	<a href="http://www.wago.com/2009-110">www.wago.com/2009-110</a>
Marker		
	<b>Item no.: 2009-115</b> WMB-Inline; for Smart Printer; 1500 pieces on roll; stretchable 5 - 5.2 mm; plain; snap-on type; white	<a href="http://www.wago.com/2009-115">www.wago.com/2009-115</a>

## Optional accessories

### Cables and pluggable connectors

Sensor/actuator cable		
	<b>Item no.: 756-5402/040-010</b> Sensor/Actuator cable; M12A socket; straight; M12A plug; angled; 4-pole; Length: 1 m	<a href="http://www.wago.com/756-5402/040-010">www.wago.com/756-5402/040-010</a>

Subject to changes. Please also observe the further product documentation!



**Item no.: 756-5402/040-020**

Sensor/Actuator cable; M12A socket; straight; M12A plug; angled; 4-pole; Length: 2 m

[www.wago.com/756-5402/040-020](http://www.wago.com/756-5402/040-020)

**Item no.: 756-5402/050-010**

Sensor/Actuator cable; M12A socket; straight; M12A plug; angled; 5-pole; Length: 1 m

[www.wago.com/756-5402/050-010](http://www.wago.com/756-5402/050-010)

**Item no.: 756-5301/050-015**

Sensor/Actuator cable; M12A socket; straight; 5-pole; Length: 1.5 m

[www.wago.com/756-5301/050-015](http://www.wago.com/756-5301/050-015)

**Item no.: 756-5311/040-050**

Sensor/Actuator cable; M12A plug; straight; 4-pole; Length: 5 m

[www.wago.com/756-5311/040-050](http://www.wago.com/756-5311/040-050)

**Item no.: 756-5311/040-015**

Sensor/Actuator cable; M12A plug; straight; 4-pole; Length: 1.5 m

[www.wago.com/756-5311/040-015](http://www.wago.com/756-5311/040-015)

**Item no.: 756-5311/040-100**

Sensor/Actuator cable; M12A plug; straight; 4-pole; Length: 10 m

[www.wago.com/756-5311/040-100](http://www.wago.com/756-5311/040-100)

**Item no.: 756-5302/050-050**

Sensor/Actuator cable; M12A socket; angled; 5-pole; Length: 5 m

[www.wago.com/756-5302/050-050](http://www.wago.com/756-5302/050-050)

**Item no.: 756-5302/050-100**

Sensor/Actuator cable; M12A socket; angled; 5-pole; Length: 10 m

[www.wago.com/756-5302/050-100](http://www.wago.com/756-5302/050-100)

**Item no.: 756-5404/050-020**

Sensor/Actuator cable; M12A socket; angled; M12A plug; angled; 5-pole; Length: 2 m

[www.wago.com/756-5404/050-020](http://www.wago.com/756-5404/050-020)

**Item no.: 756-5404/040-020**

Sensor/Actuator cable; M12A socket; angled; M12A plug; angled; 4-pole; Length: 2 m

[www.wago.com/756-5404/040-020](http://www.wago.com/756-5404/040-020)

**Item no.: 756-5404/050-010**

Sensor/Actuator cable; M12A socket; angled; M12A plug; angled; 5-pole; Length: 1 m

[www.wago.com/756-5404/050-010](http://www.wago.com/756-5404/050-010)

**Item no.: 756-5510/040-010**

Sensor/Actuator cable; M8 socket; angled; M12A plug; angled; 4-pole; Length: 1 m

[www.wago.com/756-5510/040-010](http://www.wago.com/756-5510/040-010)

**Item no.: 756-5510/040-020**

Sensor/Actuator cable; M8 socket; angled; M12A plug; angled; 4-pole; Length: 2 m

[www.wago.com/756-5510/040-020](http://www.wago.com/756-5510/040-020)

Subject to changes. Please also observe the further product documentation!

WAGO GmbH & Co. KG

Hansastr. 27

32423 Minden

Phone: +49571 887-0 | Fax: +49571 887-169

Email: [info.de@wago.com](mailto:info.de@wago.com) | Web: [www.wago.com](http://www.wago.com)

Do you have any questions about our products?

We are always happy to take your call at +49 (571) 887-44222.



**Item no.: 756-5401/040-020**

Sensor/Actuator cable; M12A socket; straight; M12A plug; straight; 4-pole; Length: 2 m

[www.wago.com/756-5401/040-020](http://www.wago.com/756-5401/040-020)

**Item no.: 756-5401/040-010**

Sensor/Actuator cable; M12A socket; straight; M12A plug; straight; 4-pole; Length: 1 m

[www.wago.com/756-5401/040-010](http://www.wago.com/756-5401/040-010)

**Item no.: 756-5507/040-010**

Sensor/Actuator cable; M8 socket; straight; M12A plug; straight; 4-pole; Length: 1 m

[www.wago.com/756-5507/040-010](http://www.wago.com/756-5507/040-010)

**Item no.: 756-5507/040-020**

Sensor/Actuator cable; M8 socket; straight; M12A plug; straight; 4-pole; Length: 2 m

[www.wago.com/756-5507/040-020](http://www.wago.com/756-5507/040-020)

**Item no.: 756-5404/040-010**

Sensor/Actuator cable; M12A socket; angled; M12A plug; angled; 4-pole; Length: 1 m

[www.wago.com/756-5404/040-010](http://www.wago.com/756-5404/040-010)

**Item no.: 756-5302/050-015**

Sensor/Actuator cable; M12A socket; angled; 5-pole; Length: 1.5 m

[www.wago.com/756-5302/050-015](http://www.wago.com/756-5302/050-015)

**Item no.: 756-5312/040-015**

Sensor/Actuator cable; M12B socket; straight; 4-pole; Length: 1.5 m

[www.wago.com/756-5312/040-015](http://www.wago.com/756-5312/040-015)

**Item no.: 756-5312/040-050**

Sensor/Actuator cable; M12B socket; straight; 4-pole; Length: 5 m

[www.wago.com/756-5312/040-050](http://www.wago.com/756-5312/040-050)

**Item no.: 756-5509/040-010**

Sensor/Actuator cable; M8 socket; angled; M12A plug; straight; 4-pole; Length: 1 m

[www.wago.com/756-5509/040-010](http://www.wago.com/756-5509/040-010)

**Item no.: 756-5509/040-020**

Sensor/Actuator cable; M8 socket; angled; M12A plug; straight; 4-pole; Length: 2 m

[www.wago.com/756-5509/040-020](http://www.wago.com/756-5509/040-020)

**Item no.: 756-5402/050-020**

Sensor/Actuator cable; M12A socket; straight; M12A plug; angled; 5-pole; Length: 2 m

[www.wago.com/756-5402/050-020](http://www.wago.com/756-5402/050-020)

**Item no.: 756-5403/040-010**

Sensor/Actuator cable; M12A socket; angled; M12A plug; straight; 4-pole; Length: 1 m

[www.wago.com/756-5403/040-010](http://www.wago.com/756-5403/040-010)

**Item no.: 756-5312/040-100**

Sensor/Actuator cable; M12B socket; straight; 4-pole; Length: 10 m

[www.wago.com/756-5312/040-100](http://www.wago.com/756-5312/040-100)

Subject to changes. Please also observe the further product documentation!

WAGO GmbH & Co. KG

Hansastr. 27

32423 Minden

Phone: +49571 887-0 | Fax: +49571 887-169

Email: [info.de@wago.com](mailto:info.de@wago.com) | Web: [www.wago.com](http://www.wago.com)

Do you have any questions about our products?

We are always happy to take your call at +49 (571) 887-44222.

**Item no.: 756-5403/040-020**  
Sensor/Actuator cable; M12A socket; angled; M12A plug; straight; 4-pole; Length: 2 m

[www.wago.com/756-5403/040-020](http://www.wago.com/756-5403/040-020)

**Item no.: 756-5403/050-020**  
Sensor/Actuator cable; M12A socket; angled; M12A plug; straight; 5-pole; Length: 2 m

[www.wago.com/756-5403/050-020](http://www.wago.com/756-5403/050-020)

**Item no.: 756-5403/050-010**  
Sensor/Actuator cable; M12A socket; angled; M12A plug; straight; 5-pole; Length: 1 m

[www.wago.com/756-5403/050-010](http://www.wago.com/756-5403/050-010)



**Item no.: 756-5508/040-010**  
Sensor/Actuator cable; M8 socket; straight; M12A plug; angled; 4-pole; Length: 1 m

[www.wago.com/756-5508/040-010](http://www.wago.com/756-5508/040-010)



**Item no.: 756-5508/040-020**  
Sensor/Actuator cable; M8 socket; straight; M12A plug; angled; 4-pole; Length: 2 m

[www.wago.com/756-5508/040-020](http://www.wago.com/756-5508/040-020)

**Item no.: 756-5301/050-100**  
Sensor/Actuator cable; M12A socket; straight; 5-pole; Length: 10 m

[www.wago.com/756-5301/050-100](http://www.wago.com/756-5301/050-100)

**Item no.: 756-5301/050-050**  
Sensor/Actuator cable; M12A socket; straight; 5-pole; Length: 5 m

[www.wago.com/756-5301/050-050](http://www.wago.com/756-5301/050-050)

**Item no.: 756-5401/050-010**  
Sensor/Actuator cable; M12A socket; straight; M12A plug; straight; 5-pole; Length: 1 m

[www.wago.com/756-5401/050-010](http://www.wago.com/756-5401/050-010)

**Item no.: 756-5401/050-020**  
Sensor/Actuator cable; M12A socket; straight; M12A plug; straight; 5-pole; Length: 2 m

[www.wago.com/756-5401/050-020](http://www.wago.com/756-5401/050-020)

#### Configurable connectors

**Item no.: 756-9202/050-000**  
Fitted pluggable connector; 5-pole; M12 plug, straight, A-coded; Spring

[www.wago.com/756-9202/050-000](http://www.wago.com/756-9202/050-000)

**Item no.: 756-9205/050-000**  
Fitted pluggable connector; 5-pole; M12 plug, right angle; Spring

[www.wago.com/756-9205/050-000](http://www.wago.com/756-9205/050-000)

**Item no.: 756-9212/050-000**  
Fitted pluggable connector; 5-pole; M12 socket, straight; Spring

[www.wago.com/756-9212/050-000](http://www.wago.com/756-9212/050-000)

**Item no.: 756-9215/050-000**  
Fitted pluggable connector; 5-pole; M12 socket, right angle; Spring

[www.wago.com/756-9215/050-000](http://www.wago.com/756-9215/050-000)

#### Distribution connector

Subject to changes. Please also observe the further product documentation!



Item no.: 756-5513/040-010

Sensor/Actuator cable; 2xM8 socket; straight; M12A plug; straight; 4-pole; Length: 1 m

[www.wago.com/756-5513/040-010](http://www.wago.com/756-5513/040-010)

Item no.: 756-5513/040-020

Sensor/Actuator cable; 2xM8 socket; straight; M12A plug; straight; 4-pole; Length: 2 m

[www.wago.com/756-5513/040-020](http://www.wago.com/756-5513/040-020)

Item no.: 756-5514/040-010

Sensor/Actuator cable; 2xM8 socket; angled; M12A plug; straight; 4-pole; Length: 1 m

[www.wago.com/756-5514/040-010](http://www.wago.com/756-5514/040-010)

Item no.: 756-5514/040-020

Sensor/Actuator cable; 2xM8 socket; angled; M12A plug; straight; 4-pole; Length: 2 m

[www.wago.com/756-5514/040-020](http://www.wago.com/756-5514/040-020)



Item no.: 756-9301/050-000

Accessories; 5-pole

[www.wago.com/756-9301/050-000](http://www.wago.com/756-9301/050-000)

Item no.: 756-9301/040-000

Accessories; 4-pole

[www.wago.com/756-9301/040-000](http://www.wago.com/756-9301/040-000)

## Downloads

### Documentation

#### Manual

16-Channel Digital Input/Output; IO-Link Class A Hub  
DC 24 V / 2.0 A; 8xM12 Connection; HubLine

V 1.1.0  
2020年11月30日

pdf  
2.9 MB

[Download](#)

#### System Description

WAGO I/O System Field; General Product Information

pdf  
708.2 kB

[Download](#)

## Engineering-Software

### WAGO IO-Link Configurator

WAGO IO-Link Configurator

V5.1.1-6015  
2021年8月24日

ZIP  
159.6 MB

[Download](#)

WAGO IO-Link Configurator allows configuration, parameterization, operation and monitoring of WAGO IO-Link Masters in the WAGO I/O System 750 and WAGO I/O System Field, and especially of the WAGO IO-Link devices connected to them.

Additionally, WAGO IO-Link Configurator can be used for complete configuration and operation of all IO-Link devices of third-party manufacturers, as long as they comply with the IO-Link specification. A product's process data can be visualized graphically and stored in trend curves. Up to eight elements can be selected for visualization, and the data can be recorded for up to 24 hours.

Subject to changes. Please also observe the further product documentation!

WAGO GmbH & Co. KG

Hansastr. 27

32423 Minden

Phone: +49571 887-0 | Fax: +49571 887-169

Email: [info.de@wago.com](mailto:info.de@wago.com) | Web: [www.wago.com](http://www.wago.com)

Do you have any questions about our products?

We are always happy to take your call at +49 (571) 887-44222.



and the data can be received for up to 2 hours.

Device description files for the IO-Link Masters (IOLM) or IO-Link Devices (IODD) can be used to integrate new devices into the tool at any time. Convenient access to the IO-Link user organization's IODDfinder is available for the IODDs. This allows automated, selective download of IODDs when integrating new IO-Link devices. An integrated IODD viewer allows detailed insight into the IODD device description.

WAGO IO-Link Configurator can be used either as a standalone program or integrated into engineering systems with a TCI interface and *WAGO-I/O-CHECK*.

IO-Link Configurator can also be used to integrate the IO-Link Master (750-657) of the WAGO I/O System 750 Series and to access all the configurator's functions. This is made possible by the WAGO I/O System 750 IO-Link Adapter, which can be retrofitted. The WAGO I/O System 750 IO-Link Adapter requires the current version of WAGO IO-Link Configurator and a current version of *WAGO-I/O-CHECK*.

In addition, the download file contains the device descriptions for the respective fieldbus systems of the WAGO I/O System Field modules. These are pre-installed in the Configurator setup.

The WAGO IO-Link Configurator license is assigned to the specific PC on which it is installed (a workstation license).

Register now and test our engineering software for 30 days at no cost.

---

## Runtime Software

### Firmware

IO-Field 765-17xx Firmware Download	V 01	zip	Download
WAGO_FW0765_17xx_V01000008_IX01.zip		341.3 kB	

---

## CAD/CAE-Data

### CAD data

2D/3D Models 765-1703/200-000	URL	Download
-------------------------------	-----	----------

### CAE data

ZUKEN Portal 765-1703/200-000	URL	Download
-------------------------------	-----	----------

---

## Environmental Product Compliance

### Compliance Search

Environmental Product Compliance 765-1703/200-000	URL	Download
16-channel digital input/output; IO Link Class A Hub; DC 24 V / 2.0 A; 8xM12 connection; HubLine		

---

## Installation Notes

Subject to changes. Please also observe the further product documentation!

---

WAGO GmbH & Co. KG  
Hansastr. 27  
32423 Minden  
Phone: +49571 887-0 | Fax: +49571 887-169  
Email: [info.de@wago.com](mailto:info.de@wago.com) | Web: [www.wago.com](http://www.wago.com)

Do you have any questions about our products?  
We are always happy to take your call at +49 (571) 887-44222.





## Product family

WAGO I/O System Field

[Show all products from the family](#)

Subject to changes. Please also observe the further product documentation!

---

WAGO GmbH & Co. KG

Hansastr. 27

32423 Minden

Phone: +49571 887-0 | Fax: +49571 887-169

Email: [info.de@wago.com](mailto:info.de@wago.com) | Web: [www.wago.com](http://www.wago.com)

Do you have any questions about our products?

We are always happy to take your call at +49 (571) 887-44222.